

ILCV2000-G34

管式单向阀

说明 DESCRIPTION

An in-line, poppet-type check valve

内嵌、锥阀式单向阀

工作 OPERATION

When pressure at ① rises above the spring bias pressure, the poppet is lifted and flow allowed from ① to ②.

The valve is closed (checked) from ② to ①.

当在①口的压力超过开启压力，①到②开启；
反方向，②到①关闭。

技术参数 SPECIFICATIONS

最大工作压力(Max.Operating Pressure):	350bar
流量(Flow):	See PRESSURE DROP VS.FLOW graph.
内泄漏(Internal Leakage):	2 drops/min(滴/分). max. at 350bar
开启压力(Crack Pressures):	<0.5bar
温度(Temperature):	-40°F to +250°F(-40°C to +120°C)
油液(Fluids):	Mineral-based fluids with viscosities of 7.4 to 420 cSt.(矿物油粘度)
阀块材料(Body Material):	Steel & Ductile iron rated to 350bar 钢和球铁允许使用最大压力350bar

SYMBOL

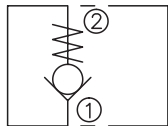

压力 - 流量曲线 PRESSURE DROP VS.FLOW

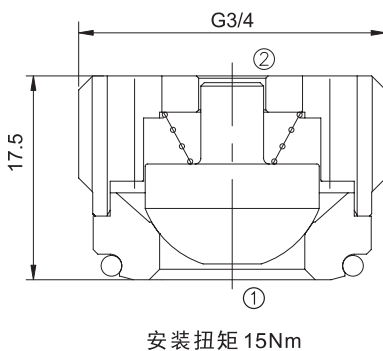
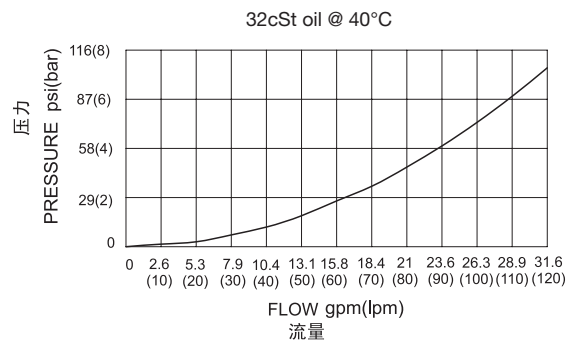

ILCV2000-G34 TOOL

